



mail: inquiry@superabrasivespowder.com

Tel: 0371-68616868

Henan E-Grind Abrasives Co. Ltd

E-Grind supplies all types PCBN Inserts for AUTO Engine Machining Industry, Aerospace Industry, Moto-cycle Industry etc.

In order to keep consistent and premium quality level, we have imported more than 60 machines from EWAG, Wendt, DMG, Coborn...

We have got ISO 9001:2000 Certified. At present our PCBN Inserts products are exported to more than 20 counties in the world such as Europe, North America, South America, Africa and Asia etc.

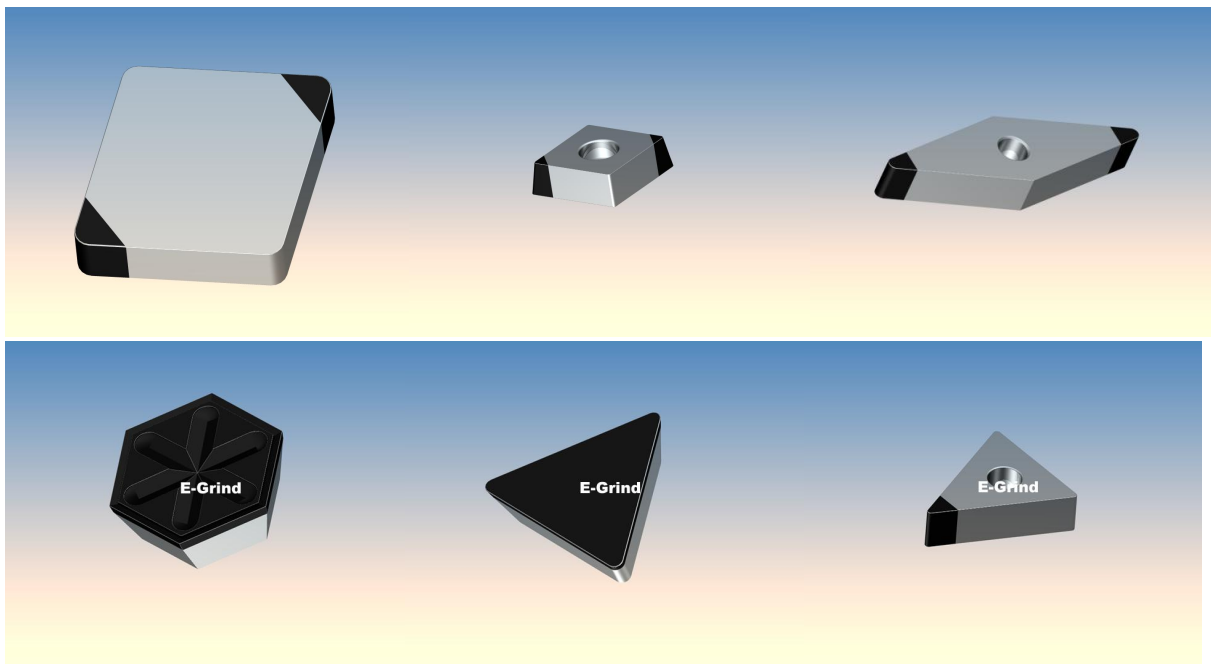

E-Grind Tool Brand Table

Grade	Characteristic	Hardness HV(Mpa)	Bending strength(Mpa)
A3N50	Fit for low speed heavy load rough machining <ul style="list-style-type: none"> •High pyroconductivity,definite impact resistance. •Fit for rough machining of high-hardness alloy cast iron, gray cast iron, nodular cast iron and other materials. 	3000--3200	1100--1300
A3N60	Fit for low speed heavy load rough machining <ul style="list-style-type: none"> •High pyroconductivity,definite wear resistance. •Fit for rough machining of high-hardness alloy cast iron, gray cast iron, nodular cast iron and other materials. 	3100--3300	1100--1200
A7N00	Consider abrasion resistance and tipping resistance, high-speed continuous cutting <ul style="list-style-type: none"> •Fit for rough machining and semifinishing of high-hardness alloy cast iron, high nickel chromium, high ferrochrome and other materials. •Fit for rough machining and semifinishing of gray cast iron and nodular cast iron. 	3200--3400	1100--1300
A7N50	Excellent wear resistance and heat resistance, high-speed continuous cutting and milling <ul style="list-style-type: none"> •Fit for semifinishing and finish machining of alloy cast iron, high nickel chromium, high ferrochrome and other materials. •Fit for semifinishing and finish machining of gray cast iron, nodular cast iron, and other materials. 	3300--3500	1100--1200
A7N60	Excellent wear resistance and heat resistance, superspeed continuous cutting and milling <ul style="list-style-type: none"> •Fit for finish machining and superfinishing of alloy cast iron, high nickel chromium, high ferrochrome and other materials. •Fit for finish machining and superfinishing of gray cast iron, nodular cast iron, etc. 	3300--3400	1100--1200
A9N00	Excellent wear resistance, tipping resistance and generality, low-speed interrupted cutting <ul style="list-style-type: none"> •Fit for rough machining of quenching workpieces, such as bearing steel, die steel, gauge steel, tool steel, high-speed steel and other materials. 	3000--3200	1100--1300
A9N50	Excellent wear resistance and heat resistance, high-speed continuous cutting and milling <ul style="list-style-type: none"> •Fit for semifinishing and finish machining of quenching workpieces, such as bearing steel, die steel, gauge steel, tool steel, high-speed steel and other materials. 	3000--3200	1100--1200
A9N60	Excellent wear resistance and heat resistance, superspeed continuous cutting and milling <ul style="list-style-type: none"> •Fit for semifinishing and finish machining of quenching workpieces, such as bearing steel, die steel, gauge steel, tool steel, high-speed steel and other materials. 	3000--3200	1100--1300

Solid PCBN inserts

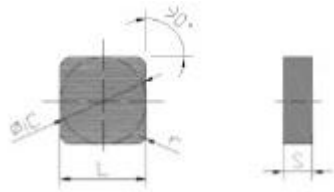
Type	Dimensions				PCBN						
ISO	L	ϕ i.c	s	r	A3N50	A7N00	A7N50	A7N60	A9N00	A9N50	A9N60
SNMN 120408	12.7	12.7	4.76	0.8	●	●	●		●	●	
SNMN 12T612	12.7	12.7	6.8	1.2	●	●	●		●	●	
SNMN 150720	15.875	15.875	7.94	2.0	●	●	●		●	●	
SNMN 201020	20.0	20.0	10.0	2.0	●	●	●		●	●	

Type	Dimensions				PCBN						
ISO	L	ϕ i.c	s	r	A3N50	A7N00	A7N50	A7N60	A9N00	A9N50	A9N60
RCMN 12T600	12.7	12.7	6.8	0	●	●	●		●	●	
RCMN 150700	15.875	15.875	7.94	0	●	●	●		●	●	
RCMN 190700	19.05	19.05	7.94	0	●	●	●		●	●	

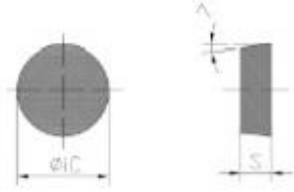
Type	Dimensions				PCBN						
ISO	L	ϕ i.c	s	r	A3N50	A7N00	A7N50	A7N60	A9N00	A9N50	A9N60
RCMX 090700	9.525	9.525	7.94	1.0	●	●	●		●	●	
RCMX 120700	12.7	12.7	7.94	2.0	●	●	●		●	●	
RCMX 151000	15.875	15.875	10.0	2.0	●	●	●		●	●	
RCMX 191000	19.05	19.05	10.0	2.0	●	●	●		●	●	
RCMX 201200	20.0	20.0	12.0	2.0	●	●	●		●	●	
RCMX 251200	25.4	25.4	12.0	2.0	●	●	●		●	●	

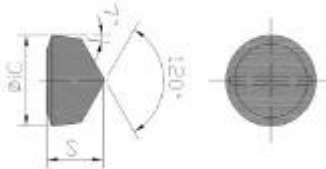

Type	Dimensions				PCBN						
ISO	L	ϕ i.c	s	r	A3N50	A7N00	A7N50	A7N60	A9N00	A9N50	A9N60
CNMN 120404	12.9	12.7	4.76	0.4	●	●	●		●	●	
CNMN 12T608	12.9	12.7	6.8	0.8	●	●	●		●	●	
RCMN 120712	12.9	12.7	7.94	1.2	●	●	●		●	●	

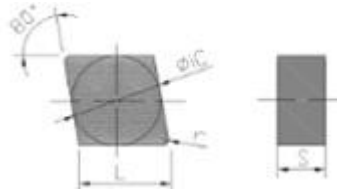

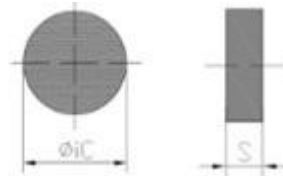
Type	Dimensions				PCBN						
ISO	L	ϕ i.c	s	r	A3N50	A7N00	A7N50	A7N60	A9N00	A9N50	A9N60
RNMN 251000	25.4	25.4	10.0	0	●	●	●		●	●	
RNMN 201000	20.0	20.0	10.0	0	●	●	●		●	●	
RNMN 200700	20.0	20.0	7.94	0	●	●	●		●	●	
RNMN 150700	15.875	15.875	7.94	0	●	●	●		●	●	
RNMN 12T600	12.7	12.7	6.80	0	●	●	●		●	●	
RNMN 120400	12.7	12.7	4.76	0	●	●	●		●	●	
RNMN 090400	9.525	9.525	4.76	0	●	●	●		●	●	
RNMN 080400	8.5	8.5	4.76	0	●	●	●		●	●	

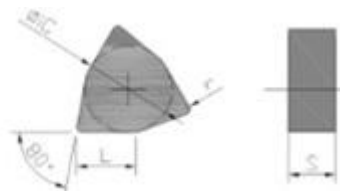

Type	Dimensions				PCBN						
ISO	L	ϕ i.c	s	r	A3N50	A7N00	A7N50	A7N60	A9N00	A9N50	A9N60
WNMN 060304T02020	6.5	9.525	3.18	0.4	●	●	●		●	●	
WNMN 080408T02020	8.72	12.7	4.76	0.8	●	●	●		●	●	
WNMN 080412T02020	8.72	12.7	4.76	1.2	●	●	●		●	●	

● Indicate Priority Selection

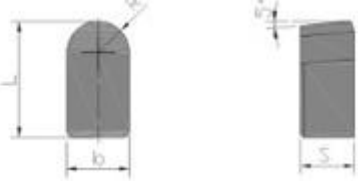
Type	Dimensions				PCBN						
ISO	R	b	L	S	A3N50	A7N00	A7N50	A7N60	A9N00	A9N50	A9N60
STB10K1	4.6	9.2	17.0	8.0	●	●	●		●	●	
BL 12K1-B	5.55	11.1	17.0	8.0	●	●	●		●	●	
BL 14K1-B	6.5	13.0	17.0	8.0	●	●	●		●	●	

Type	Dimensions				PCBN						
ISO	L	ϕ i.c	s	r	A3N50	A7N00	A7N50	A7N60	A9N00	A9N50	A9N60
RCMX090700Y	9.525	9.525	7.94	1.0	●	●	●		●	●	
RCMX120700Y	12.7	12.7	7.94	1.2	●	●	●		●	●	
RCMX150700Y	15.875	15.875	10.0	1.2	●	●	●		●	●	
RCMX190700Y	19.05	19.05	10.0	1.5	●	●	●		●	●	
RCMX200700Y	20.0	20.0	10.0	1.5	●	●	●		●	●	

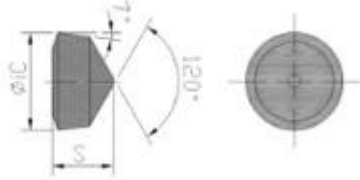

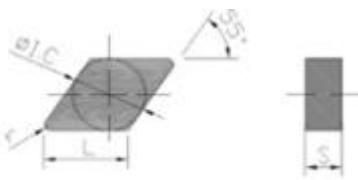

Type	Dimensions				PCBN						
ISO	L	ϕ i.c	s	r	A3N50	A7N00	A7N50	A7N60	A9N00	A9N50	A9N60
DNUN110404	11.0	9.525	4.76	0.4	●	●	●		●	●	
DNUN11T608	11.0	9.525	6.8	0.8	●	●	●		●	●	

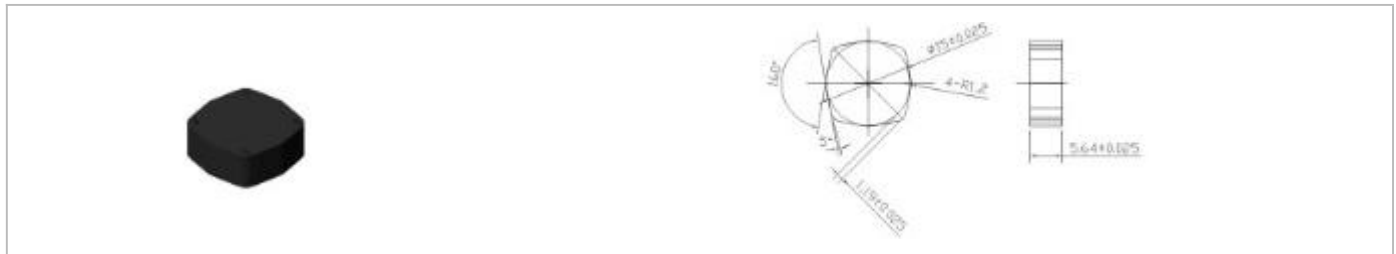

Type	Dimensions				PCBN						
------	------------	--	--	--	------	--	--	--	--	--	--

	\varnothing i.c	s	ENS	A7N00	A7N50	A9N00	A9N50
SNEN1204EDE	12.7	4.76		●	●	●	●



Type	Dimensions			PCBN			
	\varnothing i.c	s		A7N00	A7N50	A9N00	A9N50
KNK20W	15	5.64		●	●	●	●



Type	Dimensions			PCBN			
	\varnothing i.c	s		A7N00	A7N50	A9N00	A9N50
OPHN0504ZZH-A75	12.7	4.76		●	●	●	●



Type	Dimensions			PCBN			
	\varnothing i.c	s		A7N00	A7N50	A9N00	A9N50
SCGN09040822T	9.525	4.76		●	●	●	●

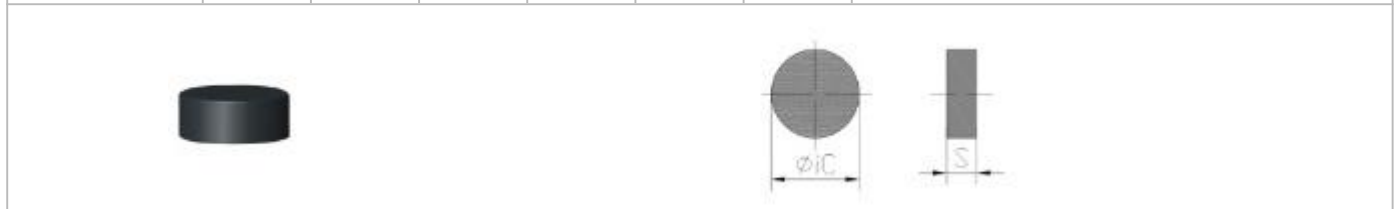

Type	Dimensions				PCBN						
ISO	L	\varnothing i.c	s	r	A3N50	A7N00	A7N50	A7N60	A9N00	A9N50	A9N60
RNEN090300	9.525	9.525	3.18	0	●	●	●		●	●	
RNEN090400	9.525	9.525	4.76	0	●	●	●		●	●	

RNEN120700	12.76	12.76	7.94	0	●	●	●		●	●	
------------	-------	-------	------	---	---	---	---	--	---	---	--

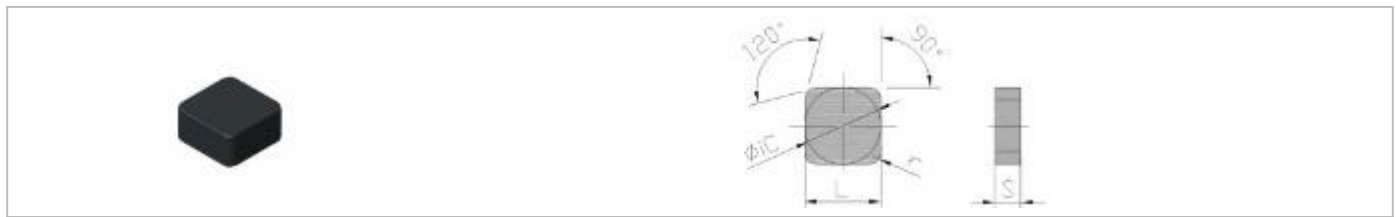

Type	Dimensions				PCBN						
ISO	L	φi.c	s	r	A3N50	A7N00	A7N50	A7N60	A9N00	A9N50	A9N60
SNEN0903ENS	9.525	9.525	3.18	0.8	●	●	●		●	●	
SNEN0904ENS	9.525	9.525	4.76	0.8	●	●	●		●	●	
SNEN1207ENS	12.7	12.7	7.94	1.2	●	●	●		●	●	
SNEN0904XGR	9.525	9.525	4.76	0.8	●	●	●		●	●	



Type	Dimensions				PCBN						
ISO	L	φi.c	s	r	A3N50	A7N00	A7N50	A7N60	A9N00	A9N50	A9N60
SNEN19T6ENS	19.05	19.05	6.8	1.6	●	●	●		●	●	
SNEN1207XGR	12.7	12.7	7.94	1.2	●	●	●		●	●	

● Indicate Priority Selection

Super Soldering Inserts

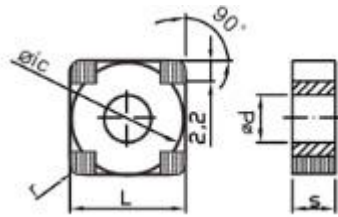

Type	Dimensions					PCBN	
	L	ϕ i.c	s	r	ϕ d	A7S50	A9N60
SNGA120404 S01020-8S	12.7	12.7	4.76	0.4	5.16		
SNGA120408 S01020-8S	12.7	12.7	4.76	0.8	5.16	●	●
SNGA120412 S01020-8S	12.7	12.7	4.76	1.2	5.16		

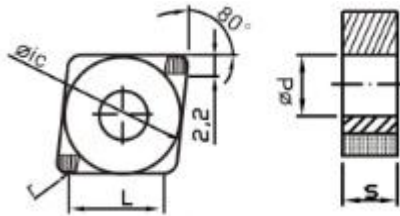

Type	Dimensions					PCBN	
	L	ϕ i.c	s	r	ϕ d	A7S50	A9N60
CNGA120404 S01020-4S	12.9	12.7	4.76	0.4	5.16		
CNGA120408 S01020-4S	12.9	12.7	4.76	0.8	5.16	●	●
CNGA120412 S01020-4S	12.9	12.7	4.76	1.2	5.16		

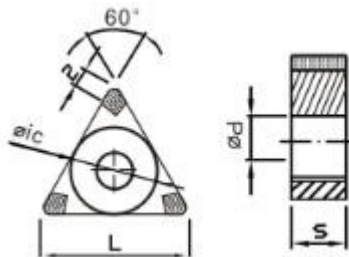

Type	Dimensions					PCBN	
	L	ϕ i.c	s	r	ϕ d	A7S50	A9N60
TNGA110304 S01020-6S	11	6.35	3.18	0.4	2.26		
TNGA110308 S01020-6S	11	6.35	3.18	0.8	2.26	●	●
TNGA110312 S01020-6S	11	6.35	3.18	1.2	2.26		

● Indicate Priority Selection

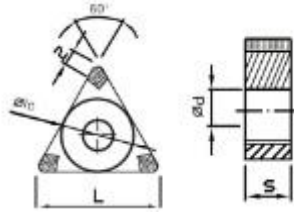
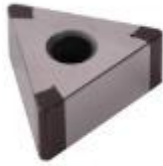

Type	Dimensions						PCBN	
	L	ϕ i.c	s	r	ϕ d	A7S50	A9N60	
TNGA160404 S01020-6S	16.5	9.525	4.76	0.4	3.81			
TNGA160408 S01020-6S	16.5	9.525	4.76	0.8	3.81	●	●	
TNGA160412 S01020-6S	16.5	9.525	4.76	1.2	3.81			

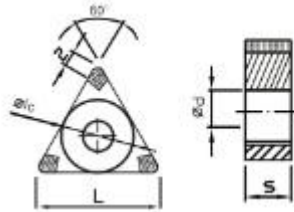
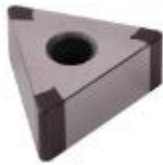

Type	Dimensions						PCBN	
	L	ϕ i.c	s	r	ϕ d	A7S50	A9N60	
TNGA220404 S01020-6S	22	12.7	4.76	0.4	5.16			
TNGA220408 S01020-6S	22	12.7	4.76	0.8	5.16	●	●	
TNGA220408 S01020-6S	22	12.7	4.76	1.2	5.16			

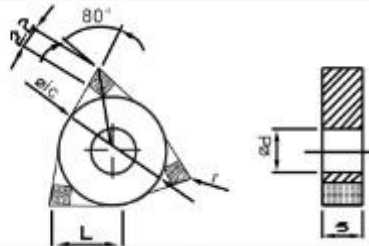
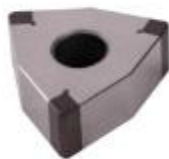

Type	Dimensions						PCBN	
	L	ϕ i.c	s	r	ϕ d	A7S50	A9N60	
WNGA080404 S01020-6S	8.7	12.7	4.76	0.4	5.16			
WNGA080408 S01020-6S	8.7	12.7	4.76	0.8	5.16	●	●	
WNGA080412 S01020-6S	8.7	12.7	4.76	1.2	5.16			

● Indicate Priority Selection

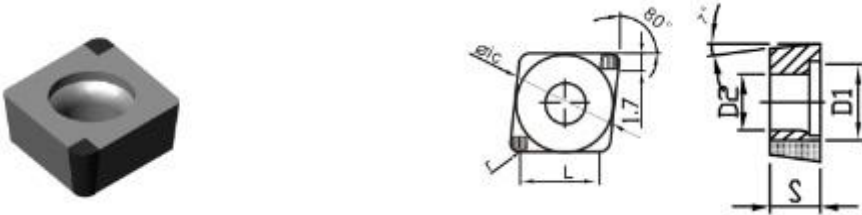

Type	Dimensions						PCBN	
	L	ϕ i.c	s	r	D1	D2	A7S50	A9N60
CCGW09T304 S01020-2S	9.67	9.525	3.97	0.4	4.4	6		
CCGW09T308 S01020-2S	9.67	9.525	3.97	0.8	4.4	6	●	●
CCGW09T312 S01020-2S	9.67	9.525	3.97	1.2	4.4	6		

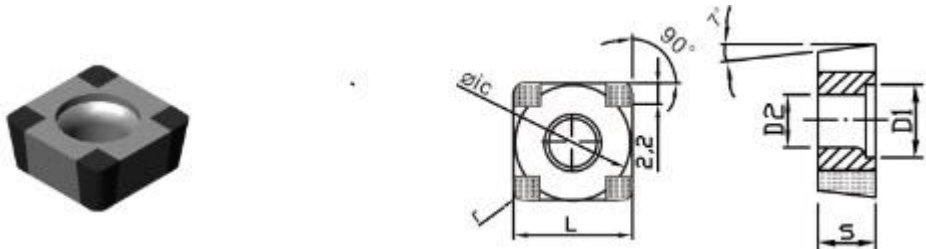

Type	Dimensions						PCBN	
	L	ϕ i.c	s	r	D1	D2	A7S50	A9N60
SCGW09T304 S01020-4S	9.67	9.525	3.97	0.4	4.4	6		
SCGW09T308 S01020-4S	9.67	9.525	3.97	0.8	4.4	6	●	●
SCGW09T312 S01020-4S	9.67	9.525	3.97	1.2	4.4	6		

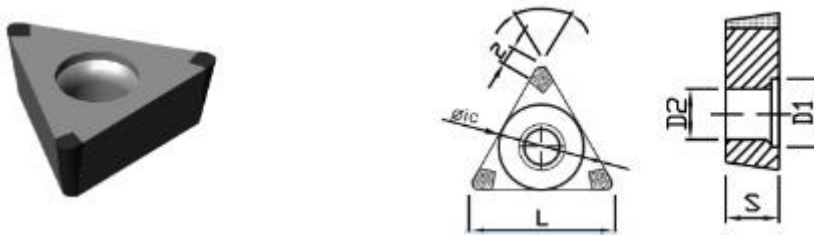

Type	Dimensions						PCBN	
	L	ϕ i.c	s	r	D1	D2	A7S50	A9N60
TCGW09T304 S01020-3S	9.67	9.525	3.97	0.4	2.5	6		
TCGW09T308 S01020-3S	9.67	9.525	3.97	0.8	2.5	6	●	●
TCGW09T312 S01020-2S	9.67	9.525	3.97	1.2	2.5	6		

● Indicate Priority Selection



mail: inquiry@superabrasivespowder.com

Tel: 0371-68616868